

500 Gal. Sand & Oil Interceptor

FLXX®

FLXX®

- PCA-000-329
- Secondary chamber volume equal to 1/2 total capacity.
- **Verify compliance with local regulations.**
- Tanks meet or exceed ASTM-C-478 specifications for water and wastewater structures.
- Butyl rubber sealant meets or exceeds Fed. Spec. SS-S-210A. (Provided with tank)
- ASSHTO H-20 traffic rated.
- Plumbing provided by others.

TOP VIEW

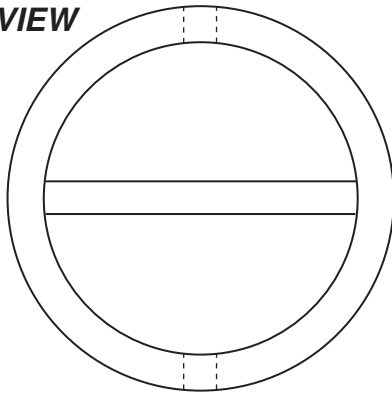

BAFFLE

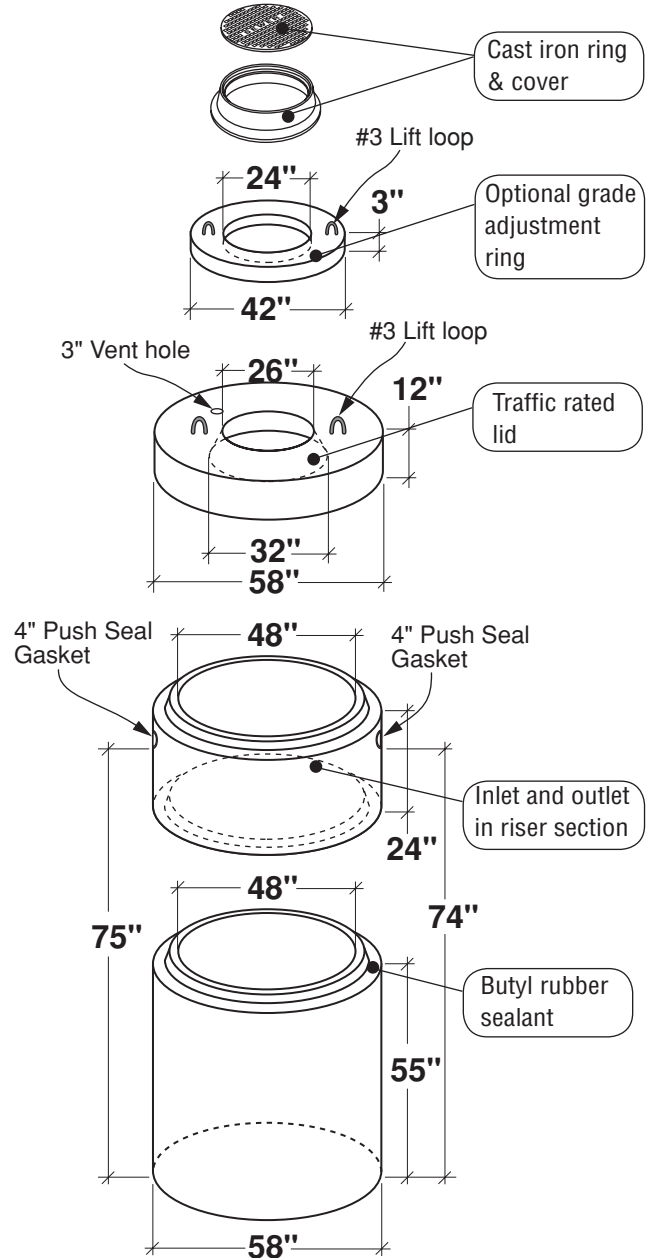
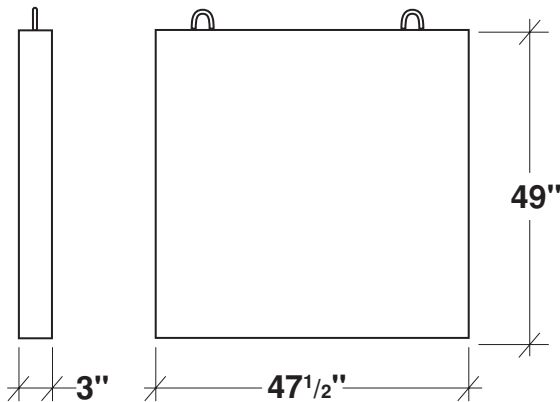

Note: N.T.S.

FLXX® 
Watertight
Front Range Precast Concrete, Inc.
 5439 N. Foothills Highway, Boulder, Colorado 80302
 Phone (303) 442-3207 • (800) 783-3207 • Fax (303) 442-3209
www.flxx.com