

Precast Manhole Base / Invert Trench Gaskets

FLXX®

FLXX®

FRPC manufactures custom monolithic manhole bases with inlets and outlets. These can be cast with or without rubber gaskets together with invert trenches to your specifications.

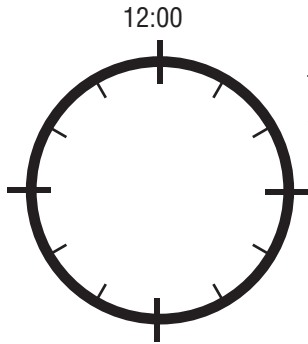

Type of pipe
Size of pipe

- Invert In/Out
- Drop rim
- Elevation
- Gaskets
- Cast-out hole
- Inlet trench

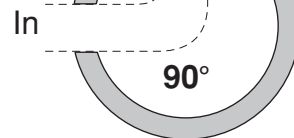
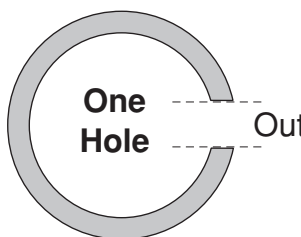
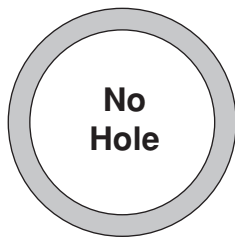
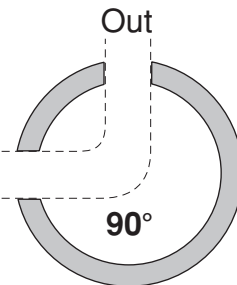
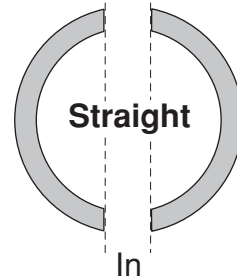
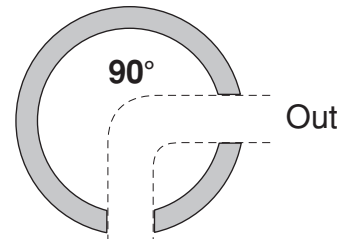
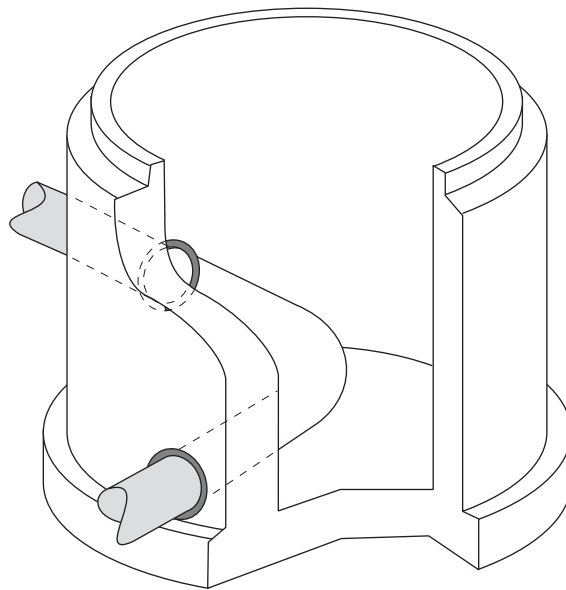

Note: N.T.S.

FLXX® 
Watertight
Front Range Precast Concrete, Inc.
 5439 N. Foothills Highway, Boulder, Colorado 80302
 Phone (303) 442-3207 • (800) 783-3207 • Fax (303) 442-3209
www.flxx.com